

- Features:
1. 4~16 circuits available;
 2. Material: LCP UL94V-0 Black/Natural;
 3. PIN Material: High conductivity copper alloy Tin-plated, SQ0.64;
 4. Mates with H250012 housing;

Specification:

Current rating: 8A at 10A .

Voltage rating: 400V AC (RMS) or 400V DC Max.

Contact resistance: 10mΩ Max.

Insulation resistance: 100MΩ Min.

Withstanding voltage: 1800VAC/minute.

Ambient temperature range: -40°C~105°C.

Dimensional information (mm)

Circuits	DIM A	DIM B
4	5.94	2.50
6	8.44	5.00
8	10.94	7.50
10	13.44	10.00
12	15.94	12.50
14	18.44	15.00
16	20.94	17.50

H250014-XX-X

SERIES NO: _____

PIN Q'PY: _____
04~16

A-BLACK (KEY A)
B-NATURE (KEY B)

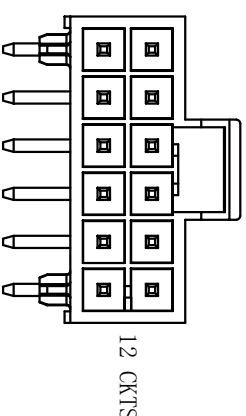
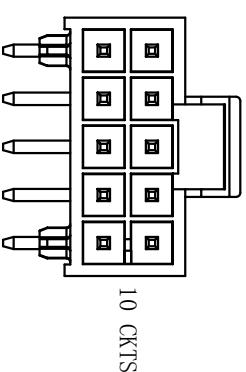
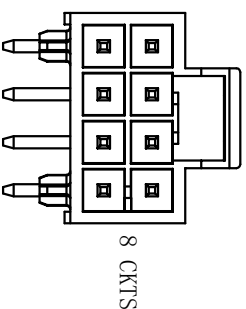
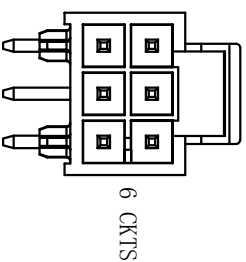
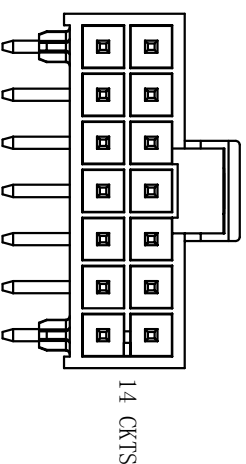
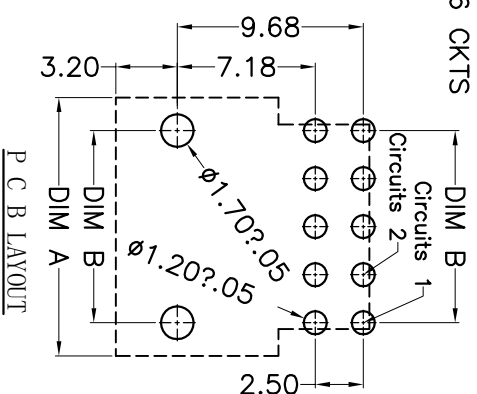
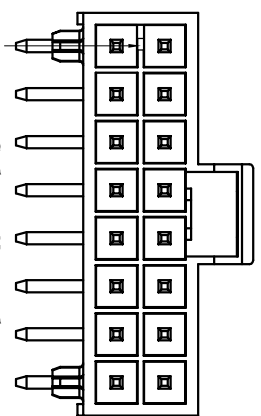
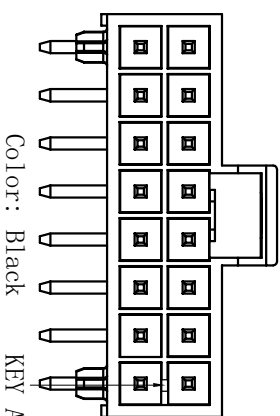
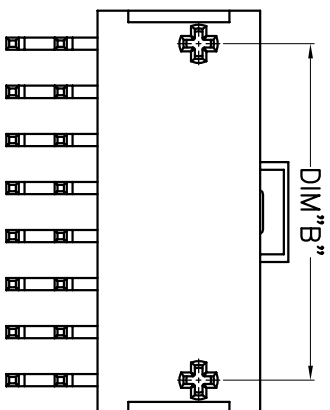
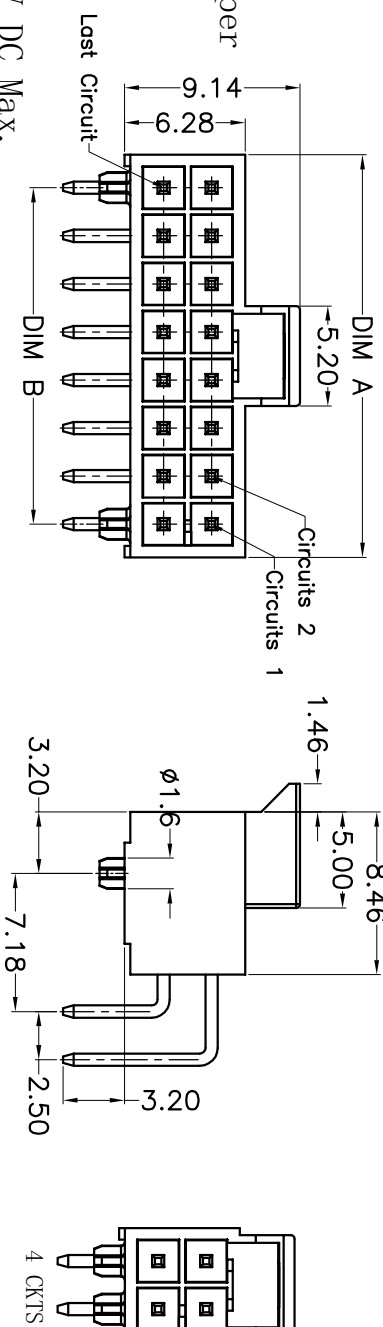

REV Description DATE GENERAL TOLERANCES (unless specified)

A 新版发行 2019-06-05

X.X±0.4

SCALE

MM

DATE

2019-03-05

东莞市恒创连接器有限公司
DONG GUAN SHI HENG CHUANG CONNECTOR COMPANY LIMITED

X.XX±0.25

REV

A

CHECKED BY

Li peng

PRODUCT NAME
2.5 mm Right Angle Dual Row header

X.XXX±0.15

APPROVAL BY

OYSW

APPROVAL BY

OYSW

PART NUMBER
H250014-XX-X