

Features:

1. 2~8 circuits available;
2. Material: PA46 UL 94V-0
3. Accepts H250011-XX terminal;
4. Mates with H2500S13, H2500S14;
5. Color: Black/Natural

Specification:

Current rating: 8A at 10A .
 Voltage rating: 400V AC(RMS) or 400V DC Max.
 Contact resistance: 10mΩ Max.
 Insulation resistance: 100MΩ Min.
 Withstanding voltage: 1800VAC/minute.
 Ambient temperature range: -40°C~105°C.

Dimensional information (mm)

Circuits	DIM A	DIM B
2	7.70	2.50
3	10.20	5.00
4	12.70	7.50
5	15.20	10.00
6	17.70	12.50
7	20.20	15.00
8	22.70	17.50

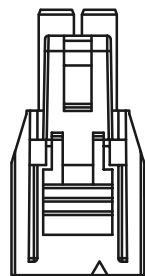
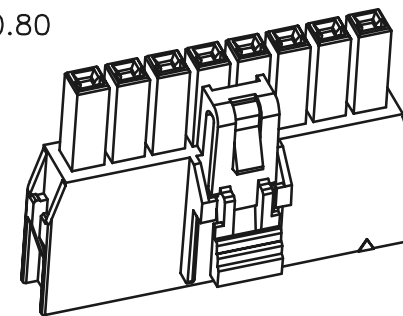
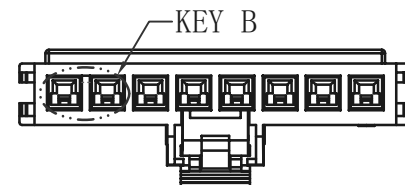
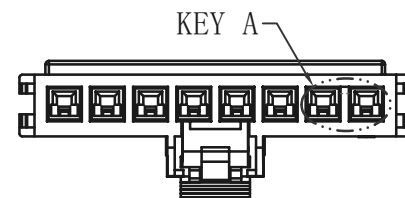
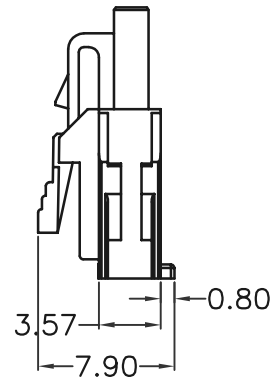
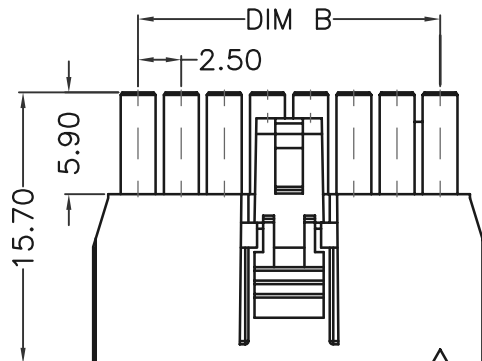
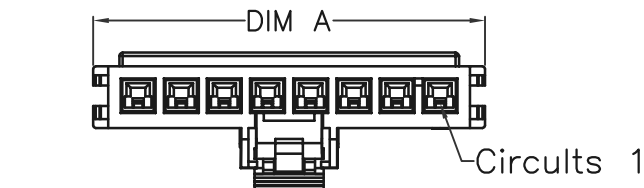

2 CKTS

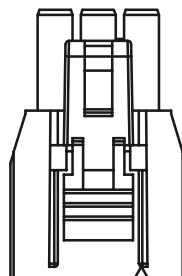

3 CKTS

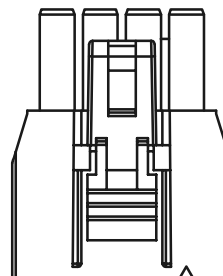

4 CKTS

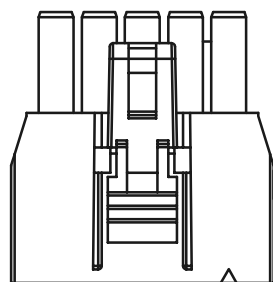

5 CKTS

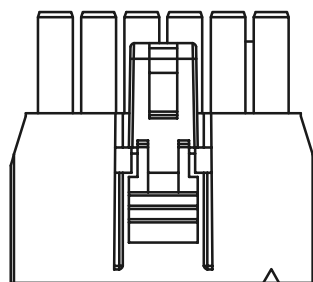

6 CKTS

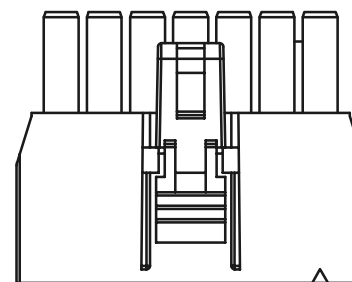

7 CKTS

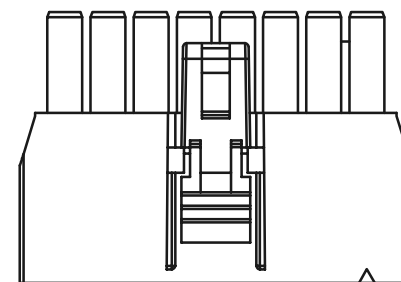

8 CKTS

H2500S12-XX-X

SERIES NO: _____

PIN Q'PY: _____
 02~08

A-BLACK (KEY A)
 B-NATURE (KEY B)

REV	Description	DATE	GENERAL TOLERANCES (unless specified)	UNITS	MM	DATE	2018-03-05
A	新版发行	2018-06-05	X.X±0.4	SCALE	1:1	DRAWING	Liu zhi guo
			X.XX±0.25	REV	A	CHECKED BY	Li peng
			X.XXX±0.15	APPROVAL BY			

东莞市恒创连接器有限公司

DONG GUAN SHI HENG CHUANG CONNECTOR COMPANY LIMITED

PRODUCT NAME 2.5 mm single row wire to Board housing

PART NUMBER H2500S12-XX-X